

Installer Guide



Universal Programmable Smart Wi-Fi Thermostats

7300 Up to 2 Heat / 1 Cool Heat Pump
1 Heat / 1 Cool Conventional

**"C" Common
Wire Required
for Wi-Fi**

7305 Up to 3 Heat / 2 Cool Heat Pump
Up to 2 Heat / 2 Cool Conventional

Model number is located on back of thermostat.

See *Wi-Fi Setup Guide for Wi-Fi Setup Instructions*

1 Specifications 2 Installation and Wiring 3 Quick Reference
4 Installer Settings 5 System Testing

 **Warning** *For installation by experienced service technicians only.*

 **Caution** • *Possible electric shock or damage to equipment can occur.*
• *Disconnect power before beginning installation.*

*This thermostat requires 24 Volt AC Power or 2 properly installed "AA" Alkaline batteries for proper operation. **If connecting this thermostat to a Wi-Fi network, a 24 VAC common (C wire) is required.***

For use only as described in this manual. Any other use will void warranty.

1 Specifications

This thermostat is compatible with:

- Single stage heat / cool conventional and heat pump systems
- Single stage heat pumps with auxiliary heat
- Conventional systems up to 2 stages of heating and 2 stages of cooling (7305 only)
- Heat pump systems up to 3 stages of heating and 2 stages of cooling (7305 only)
- 2 or 3 wire hydronic zone systems

Electrical and control specifications:

- Electrical Rating: 24 Volt AC
- 1 amp maximum load per terminal
- AC Power: 18 – 30 Volts AC
- DC Power: 3.0 Volt DC (2 "AA" Alkaline Batteries Included)
- Control Range: 45° – 90° F (7° – 32° C)
- Temperature Accuracy: +/- 1° F (+/- .5° C)
- Outdoor Temperature Display Range: -40° - 120° F (-40° - 49° C)

Terminations

- 7300: Rc, Rh, W1/E, C, Y1, K, O/B/V3, G, S2, S1
- 7305: Rc, Rh, W2, W1/E/W3, A, C, L, Y2, Y1, K, O/B/V3, G, S2, S1

2 Installation and Wiring



Warning *Disconnect power before beginning installation.*

Thermostat Location

Install the thermostat approximately 5 feet (1.5m) above the floor in an area that has a good amount of air circulation and maintains an average room temperature.

Avoid installation in locations where the thermostat can be affected by drafts, dead air spots, hot or cold air ducts, sunlight, appliances, concealed pipes, chimneys and outside walls.

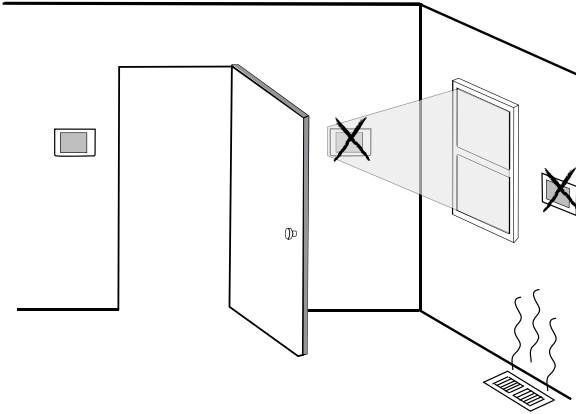

Install your new Braeburn thermostat in 4 basic steps:

- 1 Install the Sub-Base
- 2 Provide Power
- 3 Connect Your Wires
- 4 Attach Thermostat to Sub-Base

1 Install the Sub-Base:

- Remove the sub-base from the body of the thermostat.
- Mount the sub-base as shown below:

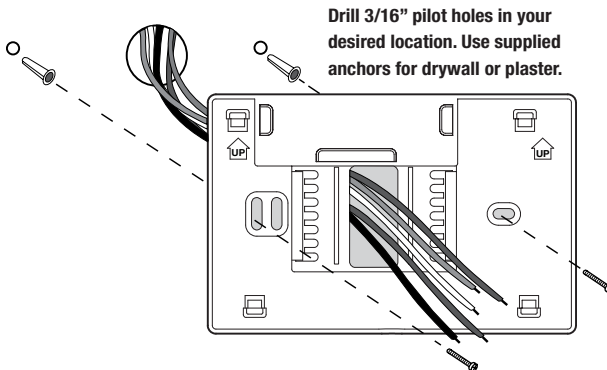

2 Provide Power

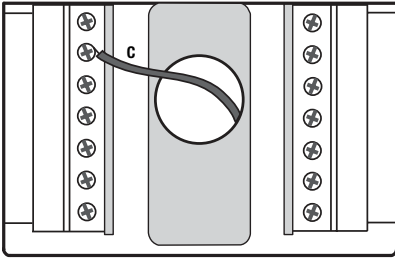

24VAC Power Terminal (C)

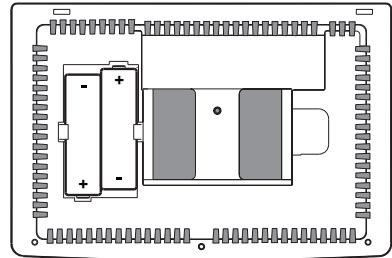

Batteries Installed as Shown

- For 24 Volt AC power, you must connect the common side of the transformer to the C terminal on the thermostat sub-base. In dual transformer installations, the transformer common must come from the cooling transformer.
- For battery power, insert the 2 supplied “AA” type alkaline batteries into the battery compartment located in the rear housing of the thermostat. Make sure to position the Positive (+) and Negative (-) sides of the batteries correctly with the +/- symbols in the battery compartment.
- **If connecting this thermostat to a Wi-Fi network, a 24 VAC common (C wire) is required.**

3 Connect Your Wires

Wiring Terminations for model 7300

Terminal	Function	Description
Rc	Input	24 Volt AC Cooling Transformer (Dual Transformer Systems Only)
Rh	Input	Power Connection (24 Volt AC Heating Transformer)
G	Output	Fan Control
W1 / E	Output	(W1) Conventional Heat Relay (E) Auxiliary/Emergency Heat
O / B / V3	Output	(O) Cool Active Reversing Valve (B) Heat Active Reversing Valve (V3) Zone Valve Power Close
Y1	Output	Compressor Relay
C	Input	24 Volt AC Transformer Common
K	-	Optional Share-a-Wire® module connection
S1	Input	Optional Remote Sensor (indoor or outdoor)
S2		

3 Connecting Your Wires (continued)

Wiring Terminations for model 7305

Terminal	Function	Description
Rc	Input	24 Volt AC Cooling Transformer (Dual Transformer Systems Only)
Rh	Input	Power Connection (24 Volt AC Heating Transformer)
G	Output	Fan Control
W1 / E / W3	Output	(W1) 1st Stage Conventional Heat, (E) Emergency Heat, (W3) 3rd Stage Auxiliary Heat
W2	Output	2nd Stage Conventional Heat
O / B / V3	Output	(O) Cool Active Reversing Valve (B) Heat Active Reversing Valve (V3) Zone Valve Power Close
Y1	Output	1st Stage Compressor
Y2	Output	2nd Stage Compressor
L	Input	System Malfunction Indicator
A	Output	Economizer, Fresh Air or Output Control
C	Input	24 Volt AC Transformer Common
K	-	Optional Share-a-Wire® module connection
S1	Input	Optional Remote Sensor (indoor or outdoor)
S2		

Conventional Systems

Typical Wiring Configurations

NOTE: The “System Type” option will be configured in the Installer Settings section.
Shaded areas do not apply to the 7300.

Heat Only

Set System Type to **11CONV**

Rh	Power Connection
W1	Heat Relay
G	Fan Relay [note 4]
C	24 Volt AC Transformer Common [note 1]

Hydronic Heat Only

Set System Type to **1HD**

Rh	24 Volt AC Power (heating transformer) [note 2]
W1	Zone Valve Power Open
V3	Zone Valve Power Close
G	Fan Relay [note 4]
C	24 Volt AC Transformer Common [note 1]

Hydronic Heat / 1 Cool

Set System Type to **11HD**

Rh	24 Volt AC Power (heating transformer) [note 2]
Rc	24 Volt AC Power (cooling transformer) [note 2]
W1	Zone Valve Power Open
V3	Zone Valve Power Close
Y1	Compressor Relay
G	Fan Relay
C	24 Volt AC Transformer Common [note 1, 3]

1 HEAT / 1 COOL Single or Dual Transformer

Set System Type to **11CONV**

Rh	24 Volt AC Power (heating transformer) [note 2]
Rc	24 Volt AC Power (cooling transformer) [note 2]
W1	Heat Relay
Y1	Compressor Relay
G	Fan Relay
C	24 Volt AC Transformer Common [note 1, 3]

2 HEAT / 2 COOL Single or Dual transformer

Set System Type to **22CONV**

Rh	24 Volt AC Power (heating transformer) [note 2]
Rc	24 Volt AC Power (cooling transformer) [note 2]
W1	Heat Relay Stage 1
W2	Heat Relay Stage 2
Y1	Compressor Relay Stage 1
Y2	Compressor Relay Stage 2 [note 4]
G	Fan Relay
C	24 Volt AC Transformer Common [note 1, 3]

NOTES - Conventional Systems

- [1]** Optional 24 Volt AC common connection (required for Wi-Fi).
- [2]** Only remove factory installed jumper for dual transformer systems.
- [3]** In dual transformer systems, transformer common must come from cooling transformer.
- [4]** If needed for system.

Provide disconnect and overload protection as required.

Heat Pump Systems

Typical Wiring Configurations

NOTE: The “System Type” option will be configured in the Installer Settings section. Shaded areas do not apply to the 7300.

1 HEAT / 1 COOL - No Auxiliary Heat

Set System Type to **11HP**

Rh	24 Volt AC Power
Rc	Connected to Rh with supplied Jumper Wire
O/B	Changeover Valve [note 2]
Y1	Compressor Relay
G	Fan Relay
C	24 Volt AC Transformer Common [note 1]

2 HEAT / 1 COOL - Including Auxiliary Heat

Set System Type to **21HP (7300 Only)**

Rh	24 Volt AC Power
Rc	Connected to Rh with supplied Jumper Wire
O/B	Changeover Valve [note 2]
Y1	Compressor Relay (1st stage heating/cooling)
E	Auxiliary/Emergency Heat Relay [note 6]
G	Fan Relay
C	24 Volt AC Transformer Common [note 1]

2 HEAT / 2 COOL - No Auxiliary Heat

Set System Type to **32HP**

Rh	24 Volt AC Power
Rc	Connected to Rh with supplied Jumper Wire
O/B	Changeover Valve [note 2]
Y1	Compressor 1 Relay (1st stage heating/cooling)
Y2	Compressor 2 Relay (2nd stage heating/cooling)
G	Fan Relay
C	24 Volt AC Transformer Common [note 1]
L	Optional System Fault Monitor [note 4]

2 HEAT / 1 COOL - Including Auxiliary Heat

Set System Type to **22HP**

Rh	24 Volt AC Power
Rc	Connected to Rh with supplied Jumper Wire
O/B	Changeover Valve [note 2]
Y1	Compressor Relay (1st stage heating/cooling)
W2	Auxiliary Heat Relay (2nd stage heating) [note 3]
E	Emergency Heat Relay [note 3]
G	Fan Relay
C	24 Volt AC Transformer Common [note 1]
L	Optional System Fault Monitor [note 4]

3 HEAT / 2 COOL – Including Auxiliary Heat

Set System Type to **32HP**

Rh	24 Volt AC Power
Rc	Connected to Rh with supplied Jumper Wire
O/B	Changeover Valve [note 2]
Y1	Compressor 1 Relay (1st stage heating/cooling)
Y2	Compressor 2 Relay (2nd stage heating/cooling)
W3	Auxiliary Heat Relay (3rd stage heating) [note 5]
G	Fan Relay
C	24 Volt AC Transformer Common [note 1]
L	Optional System Fault Monitor [note 4]

NOTES - Heat Pump Systems

- [1]** Optional 24 Volt AC common connection (required for Wi-Fi).
- [2]** O (cool active) or B (heat active) is selected in the Installer Settings menu.
- [3]** Install a field supplied jumper between the W2 and W1/E/W3 terminals if there is no separate emergency heat relay installed.
- [4]** If the L terminal is used, the 24 Volt AC common must be connected (C terminal).
- [5]** If a separate emergency heat relay is installed, the W1/E/W3 terminal should have both the auxiliary heat 1 relay and emergency heat relay connected.
- [6]** If a separate emergency heat relay is installed, the W1/E terminal should have both the auxiliary heat 1 relay and emergency heat relay connected.

Provide disconnect and overload protection as required.

Additional Wiring Options - All System Types

NOTE: Additional options are configured in the *Installer Settings* section.

S1	Indoor or Outdoor Remote Sensor [note 1]
S2	
A	Economizer, Fresh Air or Output Control (7305 Only)
K	Share-a-Wire® Module [note 2]

NOTES - Additional Wiring Options

- [1]** These terminals can be used to connect a Braeburn® indoor or outdoor remote sensor.
- [2]** Can be used to share a wire on existing installations where a common connection (C wire) is required.

4 Attach Thermostat to Sub-Base

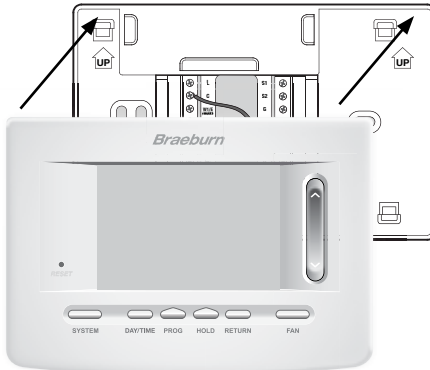

- 1) Line up the thermostat body with the sub-base.
- 2) Carefully push the thermostat body against the sub-base until it snaps in place.



- 3) Insert Quick Reference Card into slot on top of thermostat.

NOTE: This thermostat ships configured as a 1H/1C conventional thermostat. Confirm installer settings. See page 10.

3 Quick Reference

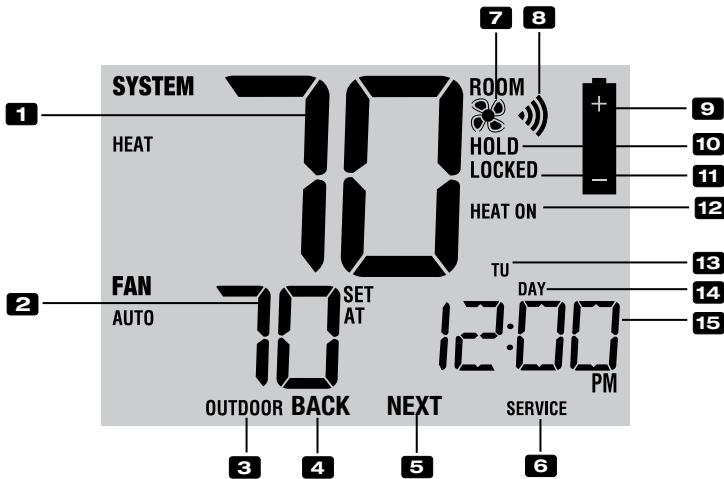

Thermostat Display

- 1** Room Temperature Displays the current room temperature
- 2** Set Temperature Displays the current set point temperature
- 3** Outdoor Temperature Indicator... Displays along with the outdoor temperature reading**
- 4** BACK Indicator* BACK button is active
- 5** NEXT Indicator* NEXT button is active
- 6** Service Indicators Displays various service/maintenance information
- 7** Fan Indicator Indicates when the system fan is running
- 8** Wi-Fi Indicator Indicates when connected to Wi-Fi (flashes when connection has been lost)
- 9** Low Battery Indicator Indicates when the batteries need to be replaced
- 10** Hold Mode Indicator Indicates if the thermostat is in HOLD mode
- 11** Lock Mode Indicator Indicates if the thermostat is locked
- 12** System Status Indicator Displays information about the status of the system
- 13** Day of the Week Displays the current day of the week
- 14** Program Event Indicator Displays the program event
- 15** Time of Day Displays the current time of day

* **BACK** and **NEXT** are secondary functions of the **PROG** and **HOLD** buttons. When in programming or configuration modes, **BACK** and **NEXT** appear in the display screen indicating that the **PROG** and **HOLD** buttons now function as **BACK** and **NEXT**.

** Also see #25 on page 9.

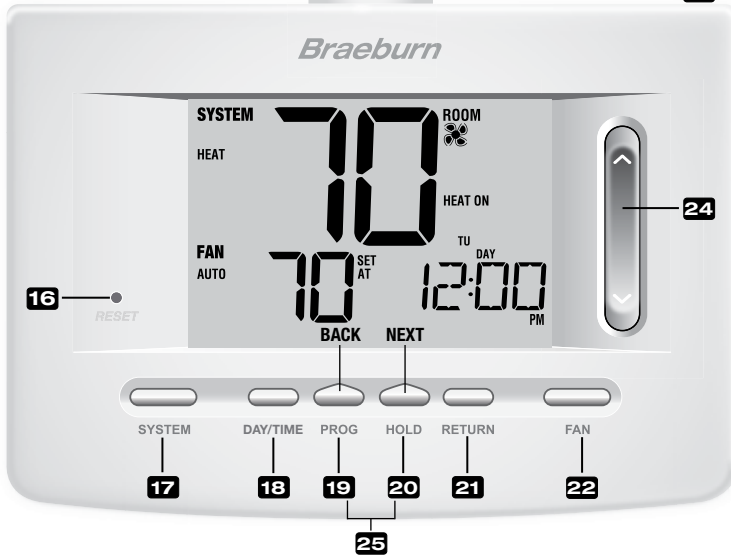

Thermostat

- 16** **Reset Button** Resets current time, program and user settings
- 17** **SYSTEM Button** Selects the system you want to control
- 18** **DAY/TIME Button**..... Sets the current time and day of the week
- 19** **PROG Button**..... Selects programming mode or press for 3 seconds to select SpeedSet®
- 19** **BACK Button***..... Secondary function of the PROG button - moves back a setting
- 20** **HOLD Button**..... Enters/Exits the HOLD mode (program bypass)
- 20** **NEXT Button*** Secondary function of the HOLD button - moves to next setting
- 21** **RETURN Button** Returns to normal mode from program or setting modes
- 22** **FAN Button** Selects the system fan mode
- 23** **Quick Reference Instructions**..... Stored in slot located at top of thermostat
- 24** **SpeedBar®** Increases or decreases settings (time, temperature, etc.)
- 25** **Outdoor Temperature**..... If a Braeburn® outdoor sensor was connected you can view the outdoor temperature by pressing the **PROG** and **HOLD** buttons at the same time.
- Battery Compartment**..... Located in the back of thermostat

* **BACK** and **NEXT** are secondary functions of the **PROG** and **HOLD** buttons. When in programming or configuration modes, **BACK** and **NEXT** appear in the display, indicating that the **PROG** and **HOLD** buttons now function as **BACK** and **NEXT**.

4 Installer Settings

The Installer Settings must be properly configured in order for this thermostat to operate correctly. The Installer Settings are menu driven. The portion of these settings that do not apply to your setup will be skipped. These settings are indicated below with comments. More detail on each setting follows this table.

1. Press and hold down the **RETURN** and **V** buttons for 3 seconds.
2. Release both buttons and the first installer setting will be displayed.
3. Change settings as required using the **▲** or **▼** portion of the SpeedBar®.
4. Press **NEXT** (HOLD) or **BACK** (PROG) to move to the next or previous setting, press **RETURN** to exit.

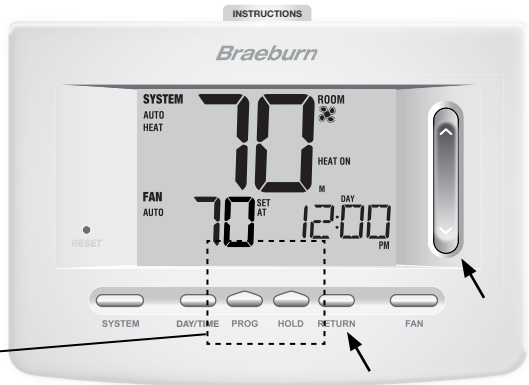
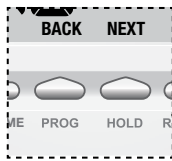

NOTE: Shaded areas below do not apply to the 7300.

No.	Installer Setting (Notes follow this table)	Factory Default	Setting Options	Comments (More information follows this table)
1	Residential or or Commercial Profile	RES	RES COMM	Select for Residential profile Select for Commercial profile
2	Programming Mode [note 1]	7PROG	7PROG 52PROG NO PROG	Select for 7 day programming mode Select for 5-2 day programming mode Select for non-programmable mode
3	Clock Format	12 HR	12 HR 24 HR	Select for 12 hour clock Select for 24 hour clock
4	Temperature Scale	F DEG	F DEG C DEG	Select for Fahrenheit display Select for Celsius display
5	Auto Changeover	oF AUTO	oF AUTO oN AUTO	Disables Auto Changeover mode Enables Auto Changeover mode
6	System Type	11CONV	11CONV	Select for 1H/1C Conventional system
			22CONV	Select for 2H/2C Conventional system
			11HP	Select for 1H/1C Heat Pump system
			21HP	Select for 2H/1C Heat Pump system (7300 Only)
			22HP	Select for 2H/2C Heat Pump system
			32HP	Select for 3H/2C Heat Pump system
7	1st Stage Differential	0.5 DIF1	0.5, 1.0 or 2.0 DIF1	Select a 1st stage temperature differential of .5°, 1° or 2° F (.25°, .5° or 2° C)
			8	2nd Stage Differential [note 2]
9	3rd Stage Differential [note 2]	2.0 DIF3	1.0, 2.0, 3.0, 4.0, 5.0 or 6.0 DIF3	Select a 3rd stage temperature differential of 1°, 2°, 3°, 4°, 5° or 6° F (.5°, 1°, 1.5°, 2°, 2.5° or 3° C)

No.	Installer Setting (Notes follow this table)	Factory Default	Setting Options	Comments (More information follows this table)
10	1st Stage Fan Control [note 3]	HG FAN 1	HG FAN 1 HE FAN 1	Select for 1st stage Gas heating Select for 1st stage Electric heating
11	Emergency Heat Fan Control [note 4]	HE EMER	HE EMER HG EMER	Select for Electric Emergency Heat Select for Gas Emergency Heat
12	Reversing Valve (O/B Terminal) [note 5]	REVO	REVO REVB	Select for cool active Reversing Valve (O terminal) Select for heat active Reversing Valve (B terminal)
13	Fossil Fuel Backup Heat [note 4]	AE AUX	AE AUX AG AUX	Select for Electric Auxiliary heat (with compressor) Select for Gas Auxiliary heat (without compressor)
14	Compressor Power Outage Protection [notes 4, 6]	oF CPOP	oF CPOP oM CPOP	Disables Power Outage Lockout Delay Enables Power Outage Lockout Delay
15	AC Power Interrupt Warning [note 6]	AC oF MONR	AC oF MONR AC oM MONR	Disables AC Power Interrupt Warning Enables AC Power Interrupt Warning
16	Compressor Short Cycle Protection [note 7]	5 CSCP	5, 4, 3, 2 or 0 CSCP	Select a compressor short cycle protection delay of 5, 4, 3, 2 or 0 minutes
17	Residual Cooling Fan Delay [note 7]	60 FAN	90, 60, 30 or 0 FAN	Select a Residual Cooling Fan Delay of 90, 60, 30 or 0 seconds.
18	Circulating Fan Lock	oF CIRC	oF CIRC oM CIRC	Disables Circulating Fan Lock mode Enables Circulating Fan Lock mode
19	Adaptive Recovery Mode (ARM™) [note 8]	oF REC	oF REC oM REC	Disables Adaptive (early) Recovery mode Enables Adaptive (early) Recovery mode
20	Indoor Remote Sensor Control* [note 9]	1 SENS	1 SENS E SENS A SENS	Temperature is sensed from thermostat only. Temperature is sensed from remote sensor only. Temperature is combined with the thermostat and the remote sensor.
21	Lockout Security Level	2 LOCK	2 LOCK 1 LOCK	If locked – Complete lockout is enabled If locked – Partial lockout is enabled (SpeedBar® is still functional)
22	Auto Changeover Dead Band [note 10]	3 BAND	2, 3, 4 or 5 BAND	Select a Dead Band of 2°, 3°, 4° or 5° F (1°, 2° or 3° C) for Auto Changeover mode.
23	Compressor Balance Point [notes 4, 11]	NO BALC	NO BALC 0-50 BALC	Disables Balance Points Select a Compressor Balance Point of 0°- 50°F (-9°-10° C)
24	Auxiliary Heat Balance Point [notes 4, 11]	NO BALA	NO BALA 70-40 BALA	Disables Balance Points Select a Auxiliary Heat Balance Point of 70°- 40° F (21°- 4° C)
25	Economizer Fresh Air or Output Control [note 12]	OR NONE	OR NONE OR ECON OR TOD	Disables Fresh Air Intake option Enables Fresh Air Intake (Economizer Mode) Enables Fresh Air Intake (Time of Day Mode)
26	Heat Set Point Upper Limit	90 LiM	90-60 LiM	Select a Heat Set Point Upper Limit of 90°-60° F (32°-10° C)
27	Cool Set Point Lower Limit [note 7]	45 LiM	45-80 LiM	Select a Cool Set Point Lower Limit of 45°-80° F (7°-27° C)
28	Installer Clear	CLR0	CLR0 CLR2	Clear Off - No changes made to settings Clears all thermostat settings (factory defaults)

*When a Braeburn® outdoor sensor is connected, the thermostat automatically recognizes it. Press **PROG** and **HOLD** at the same time to display outdoor temperature.

NOTE: Additional options such as *Service Monitors, setting the lock code, etc. are located in the User Settings – See User manual for information on setting these options.*

NOTES - Installer Settings

- 1 Only available if Residential profile was selected in option 1.
- 2 Only available if a 2 or 3 stage system type was selected in option 6.
- 3 Only available if a Conventional system was selected in option 6.
- 4 Only available if a 2 or 3 stage Heat Pump system was selected in option 6.
- 5 Only available if a Heat Pump system was selected in option 6.
- 6 Only available if the 24 Volt AC common wire is connected to the C terminal.
- 7 Not available if a heat only hydronic system is selected in option 6.
- 8 Only available if a programmable profile was selected in option 2.
- 9 Only available if a Braeburn® indoor remote sensor was connected.
- 10 Only available if auto changeover was enabled in option 5.
- 11 Only available if a Braeburn outdoor sensor was connected.
- 12 Only available if a Commercial profile was selected in option 1.

Detailed Explanation of Installer Settings (also see NOTES above):

- 1 **Profile** – Selects a residential (RES) or commercial (COMM) profile. If residential is selected, 4 programming events per day are available. If commercial is selected, 2 event, 7 day programming is available.
- 2 **Programming Mode [note 1]** – Selects the programming mode, either full 7 day or 5-2 day (weekday/ weekend) programming or non-programmable.
- 3 **Clock Type** – Selects either a 12 hour or 24 hour clock.
- 4 **Temperature Scale** – Selects a temperature scale of either °F or °C.
- 5 **Auto Changeover** – Selects auto changeover on or off. When auto changeover mode is enabled and selected, the system automatically switches between heating and cooling modes. There is a 5 minute delay when switching from heating to cooling or cooling to heating in auto changeover mode.
NOTE: Also see “Auto Changeover Dead Band” in option 21.
- 6 **System Type** – Selects the system type for your installation. **NOTE:** Changes made to this option will reset options 7 through 15 back to their default values dependant on the system type.
- 7 **1st Stage Differential** – Selects a 1st stage temperature differential.
- 8 **2nd Stage Differential [note 2]** – Selects a 2nd stage temperature differential.
- 9 **3rd Stage Differential [note 2]** – Selects a 3rd stage temperature differential.
- 10 **1st Stage Fan Control [note 3]** – Selects a 1st stage fan control of either gas or electric heat.
- 11 **Emergency Heat Fan Control [note 4]** – Selects emergency heat fan control of either gas or electric heat.
- 12 **Reversing Valve [note 5]** – Selects the output state of the O/B terminal. Select O for this terminal to be active in the cool mode or select B for this terminal to be active in the heat mode.
- 13 **Auxiliary Fossil Fuel Heat Pump Control [note 4]** – When set to electric (AE AUX), both the compressor (1st stage) and auxiliary stage(s) will run when a call for auxiliary heat is made. When set to gas (AG AUX), the compressor stage(s) will be locked out one minute after a call for auxiliary heat. **NOTE:** This option can be overridden if setting an auxiliary heat balance point in Option 23.
- 14 **Compressor Power Outage Protection [notes 4, 6]** – Selects power outage protection on or off. When enabled, this thermostat will provide cold weather compressor protection by locking out the compressor stage(s) of heating for a period of time after a power outage greater than 60 minutes.
- 15 **AC Power Interrupt Warning [note 6]** – When enabled, the thermostat will display an outage warning when AC power to the thermostat is lost.

- 16 Short Cycle Protection [note 7]** – Selects the number of minutes the cooling compressor will be locked out after turning off. This short cycle protection is also active in the heat mode if a heat pump system was selected in Option 6.
- 17 Residual Cooling Fan Delay [note 7]** – Selects a delay for the system fan after the cooling compressor has turned off. This delay will help remove the remaining cool air out of the ductwork providing additional efficiency.
- 18 Circulating Fan Lock** – When enabled, the only user fan options available are ON and CIRC (Circulation). The AUTO option is not available with this option enabled.
- 19 Adaptive Recovery Mode (early recovery) [note 8]** – Enables or disables the ARM™ (adaptive recovery mode) feature. During ARM, room temperature is recovered by turning on the heating or cooling before the end of the set back period. The set point temperature is changed to that of the upcoming program temperature.
- 20 Indoor Remote Sensor Control [note 9]** – If a Braeburn® indoor remote sensor is connected during installation, the thermostat will automatically detect the sensor. When an indoor sensor is detected, you may select between thermostat only (I SENS), remote sensor only (E SENS) or combining the thermostat and the remote sensor (A SENS). **NOTE:** *This option does not apply to a Braeburn outdoor sensor. When an outdoor sensor is connected the thermostat automatically recognizes it and no further configuration is necessary.*
- 21 Lockout Security Level** – Selects the level of keypad lockout when the thermostat is locked. Level 2 locks the entire thermostat (including the front reset button). Level 1 locks everything except the SpeedBar® allowing for up and down temperature adjustment. **NOTE:** *The lock code is set in the User Settings mode (see User Manual).*
- 22 Auto Changeover Dead Band [note 10]** – When auto changeover mode is enabled in option 5 and selected, the system automatically switches between heating and cooling when the room temperature meets the normal criteria for either a heating or cooling call. There is a forced separation (dead band) between the heating and cooling set points so that the systems do not work against each other. This option selects the amount of this dead band in degrees with the default being 3° F.
- 23 Compressor Balance Point [notes 4, 11]** – Locks out the use of the compressor heat stage when the outside air temperature is less than the selected setting of 15° F to 50° F (-9° C to 10° C)
- 24 Auxiliary Heat Balance Point [notes 4, 11]** – Locks out the use of the auxiliary heat stage when the outside air temperature exceeds the selected setting of 70° F to 40° F (21° C to 4° C). **NOTE:** *This balance point overrides the fossil fuel compressor lockout in option 13. If this option is set to gas and the outdoor temperature is over the auxiliary balance point, the compressor will remain on during a call for auxiliary heat.*

Continued

25 Economizer, Fresh Air or Output Control [note 12] – Selects control options. Select between disabled (NONE), economizer mode (ECON) and time of day (TOD) mode.

Time Step / Override	Cooling Call	External Air or Output Control (A)		
		Economizer Mode	Time of Day Mode	Disabled
Occupied	YES or NO	ON	ON	OFF
Unoccupied	YES	ON	OFF	OFF
	NO	OFF	OFF	OFF
Override	YES or NO	ON	ON	OFF

Time Step / Override	Heating Call	External Air Output (A)		
		Economizer Mode	Time of Day Mode	Disabled
Occupied	YES or NO	ON	ON	OFF
Unoccupied	YES	OFF	OFF	OFF
	NO	OFF	OFF	OFF
Override	YES or NO	ON	ON	OFF

26 Heat Set Point Upper Limit – Selects the heating set point upper adjustment limit.

27 Cool Set Point Lower Limit [note 7] – Selects the cooling set point lower adjustment limit.

28 Installer Clear – Clears settings based on your selection. CLRO makes no changes and CLR2 clears **ALL** thermostat settings to factory default.

WARNING: If you press NEXT or RETURN after selecting CLR2 the clear will take place and the appropriate settings will be returned to factory defaults. If you do not wish to make any changes, use the SpeedBar® to select CLRO.

5 System Testing



Warning *Read Before Testing*

- Do not short (or jumper) across terminals on the gas valve or at the heating or cooling system control board to test the thermostat installation. This could damage the thermostat and void the warranty.
- Do not select the COOL mode of operation if the outside temperature is below 50° F (10° C). This could possibly damage the controlled cooling system and may cause personal injury.
- This thermostat includes an automatic compressor protection feature to avoid potential damage to the compressor from short cycling. When testing the system, make sure to take this delay into account.

NOTE: *The compressor delay can be bypassed by pressing the reset button on the front of the thermostat. All user settings will be returned to factory default, however all Installer settings will remain as originally programmed in section 4.*

- 1 Press the **SYSTEM** button until the thermostat is in HEAT mode.
- 2 Using the SpeedBar® raise the set temperature a minimum of 3 degrees above the current room temperature. The system should start within a few seconds. With a gas heating system, the fan may not start right away.
- 3 Press **SYSTEM** until the thermostat is in the OFF mode. Allow the heating system to fully shut down.
- 4 Press **SYSTEM** until the thermostat is in the COOL mode.
- 5 Using the SpeedBar lower the set temperature a minimum of 3 degrees below the current room temperature. The system should start within a few seconds (unless compressor short cycle protection is active – See note above).
- 6 Press **SYSTEM** until the thermostat is in the OFF mode. Allow the cooling system to fully shut down.
- 7 Press **FAN** until the thermostat is in FAN ON mode. The system fan should start within a few seconds.
- 8 Press **FAN** until the thermostat is in FAN AUTO mode. Allow the system fan to turn off.

This equipment has been tested and found to comply with the limits for a Class B digital device, pursuant to Part 15 of the FCC Rules. These limits are designed to provide reasonable protection against harmful interference in a residential installation. This equipment generates uses and can radiate radio frequency energy and, if not installed and used in accordance with the instructions, may cause harmful interference to radio communications. However, there is no guarantee that interference will not occur in a particular installation. If this equipment does cause harmful interference to radio or television reception, which can be determined by turning the equipment off and on, the user is encouraged to try to correct the interference by one or more of the following measures:

- Reorient or relocate the receiving antenna.
- Increase the separation between the equipment and receiver.
- Connect the equipment into an outlet on a circuit different from that to which the receiver is connected.
- Consult the dealer or an experienced radio/TV technician for help.

Changes or modifications not expressly approved by the party responsible for compliance could void the user's authority to operate the equipment. This device complies with part 15 of the FCC Rules. Operation is subject to the following two conditions: (1) This device may not cause harmful interference, and (2) this device must accept any interference received, including interference that may cause undesired operation.

This device complies with Industry Canada's licence-exempt RSSs. Operation is subject to the following two conditions:

- (1) This device may not cause interference; and
- (2) This device must accept any interference received, including interference that may cause undesired operation of the device.

Cet appareil est conforme aux CNR exempts de licence d'Industrie Canada. Son fonctionnement est soumis aux deux conditions suivantes :

- (1) Ce dispositif ne peut causer des interférences ; et
- (2) Ce dispositif doit accepter toute interférence, y compris les interférences qui peuvent causer un mauvais fonctionnement de l'appareil.

Please Note: This thermostat may have been updated over the internet since this manual was printed. Always refer to the support web site for the latest information.

Limited Warranty

When installed by a professional contractor, this product is backed by a 5 year limited warranty. Limitations apply. For limitations, terms and conditions, you may obtain a full copy of this warranty:

- Visit us online: www.braeburnonline.com/warranty
- Phone us: 866.268.5599
- Write us: Braeburn Systems LLC
2215 Cornell Avenue
Montgomery, IL 60538



Store this manual for future reference.

For additional information visit: www.braeburnonline.com

For online access visit: www.bluelinksmartconnect.com

Braeburn®

Braeburn Systems LLC
2215 Cornell Avenue • Montgomery, IL 60538
Technical Assistance: www.braeburnonline.com
Call us toll-free: 866-268-5599 (U.S.)
630-844-1968 (Outside the U.S.)