

# Installer Guide

## Universal Programmable Smart Wi-Fi Thermostat

**7320** Up to 3 Heat / 2 Cool Heat Pump  
Up to 2 Heat / 2 Cool Conventional  
with wireless Humidity Control\*

*Model number is located on back of thermostat.*

### **See Wi-Fi Setup Guide for Wi-Fi Setup Instructions**

**1 Specifications 2 Installation and Wiring 3 Quick Reference  
4 Installer Settings 5 Wireless Remote Sensors 6 System Testing**

 **Attention** *To prevent damage to the thermostat, never use a sharp instrument to press the touchscreen keys. Always press keys with your fingers.*

 **Warning** *For installation by experienced service technicians only.*

 **Caution** • *Possible electric shock or damage to equipment can occur.*  
• *Disconnect power before beginning installation.*

*This thermostat requires 24 Volt AC Power or 2 properly installed “AA” Alkaline batteries for proper operation. If connecting this thermostat to a Wi-Fi network, a 24 VAC common (C wire) is required.*

***For use only as described in this manual. Any other use will void warranty.***

## **1 Specifications**

### **This thermostat is compatible with:**

- Single stage heat / cool conventional and heat pump systems
- Conventional systems up to 2 stages of heating and 2 stages of cooling
- Heat pump systems up to 3 stages of heating and 2 stages of cooling

### **Electrical and control specifications:**

- Electrical Rating: 24 Volt AC
- 1 amp maximum load per terminal, 6 amp maximum load
- AC Power: 18 – 30 Volts AC
- DC Power: 3.0 Volt DC (2 “AA” Alkaline Batteries Included)
- Control Range: 45° – 90° F (7° – 32° C)
- Temperature Accuracy: +/- 1° F (+/- .5° C)
- Outdoor Temperature Display Range: -40° - 120° F (-40° - 49° C)

### **Terminations:**

Rc, Rh, C, W2/AUX, W1/E, L, A, O/B, G, Y2, Y1, K, S2, S1

\* Wireless Humidity Control requires accessory model 7330.

## 2 Installation and Wiring

**Warning** *Disconnect power before beginning installation.*

### Thermostat Location

Install the thermostat approximately 5 feet (1.5m) above the floor in an area that has a good amount of air circulation and maintains an average room temperature.

Avoid installation in locations where the thermostat can be affected by drafts, dead air spots, hot or cold air ducts, sunlight, appliances, concealed pipes, chimneys and outside walls.

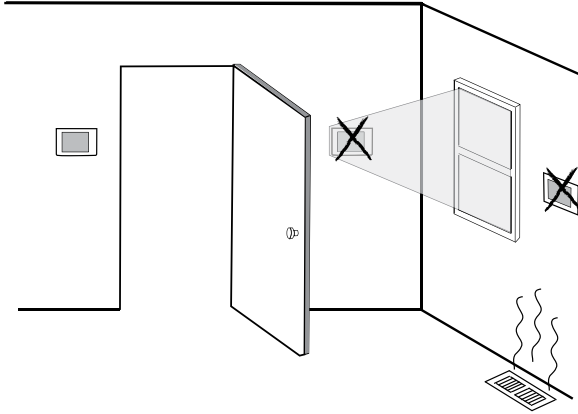

### Install your new Braeburn thermostat in 4 basic steps:

- 1 Install the Sub-Base
- 2 Provide Power
- 3 Connect Your Wires
- 4 Attach Thermostat to Sub-Base

#### 1 Install the Sub-Base:

- Remove the sub-base from the body of the thermostat.
- Mount the sub-base as shown below:

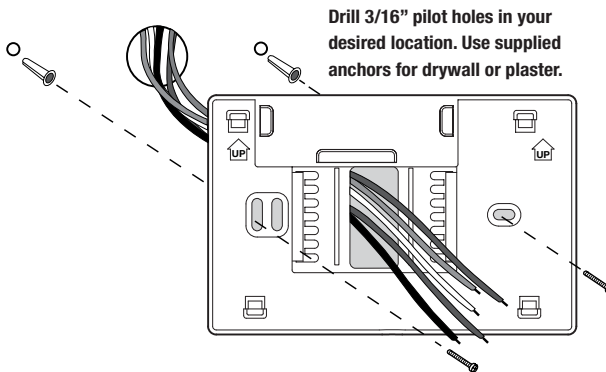

## 2 Provide Power

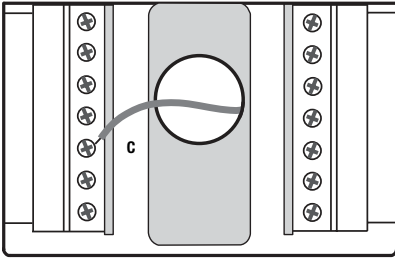

24VAC Power Terminal (C)

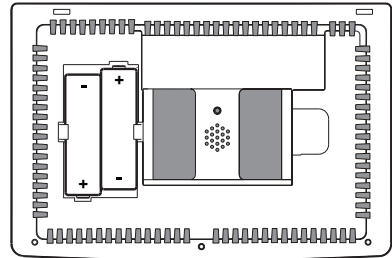

Batteries Installed as Shown

- For 24 Volt AC power, you must connect the common side of the transformer to the C terminal on the thermostat sub-base. In dual transformer installations, the transformer common must come from the cooling transformer.
- For battery power, insert the 2 supplied "AA" type alkaline batteries into the battery compartment located in the rear housing of the thermostat. Make sure to position the Positive (+) and Negative (-) sides of the batteries correctly with the +/- symbols in the battery compartment.
- If connecting this thermostat to a Wi-Fi network, a 24 VAC common (C wire) is required.

## 3 Connect Your Wires

Terminal	Function	Description
Rc	Input	24 Volt AC Cooling Transformer (Dual Transformer Systems Only)
Rh	Input	Power Connection (24 Volt AC Heating Transformer)
C	Input	24 Volt AC Transformer Common
W2 / AUX	Output	(W2) 2nd Stage Conventional Heat (AUX) Auxiliary Heat (Heat Pump)
W1 / E	Output	(W1) 1st Stage Conventional Heat (E) Emergency Heat
L	Input	System Malfunction Indicator
A	Output	Economizer, Fresh Air or Output Control
O / B	Output	(O) Cool Active Reversing Valve (B) Heat Active Reversing Valve
G	Output	Fan Control
Y2	Output	2nd Stage Compressor
Y1	Output	1st Stage Compressor
K	-	Optional Share-a-Wire™ module connection
S2	Input	Optional Wired Remote Sensor (indoor or outdoor)
S1		

## Conventional Systems

### Typical Wiring Configurations

**NOTE:** The “System Type” option will be configured in the Installer Settings section.

#### Heat Only

Set System Type to **11CONV**

<b>Rh</b>	24 Volt AC Power
<b>W1</b>	Heat Relay
<b>G</b>	Fan Relay <b>[note 4]</b>
<b>C</b>	24 Volt AC Transformer Common <b>[note 1]</b>

#### 1 HEAT / 1 COOL Single or Dual Transformer

Set System Type to **11CONV**

<b>Rh</b>	24 Volt AC Power (heating transformer) <b>[note 2]</b>
<b>Rc</b>	24 Volt AC Power (cooling transformer) <b>[note 2]</b>
<b>W1</b>	Heat Relay
<b>Y1</b>	Compressor Relay
<b>G</b>	Fan Relay
<b>C</b>	24 Volt AC Transformer Common <b>[note 1, 3]</b>

#### 2 HEAT / 2 COOL Single or Dual transformer

Set System Type to **22CONV**

<b>Rh</b>	24 Volt AC Power (heating transformer) <b>[note 2]</b>
<b>Rc</b>	24 Volt AC Power (cooling transformer) <b>[note 2]</b>
<b>W1</b>	Heat Relay Stage 1
<b>W2</b>	Heat Relay Stage 2
<b>Y1</b>	Compressor Relay Stage 1
<b>Y2</b>	Compressor Relay Stage 2 <b>[note 4]</b>
<b>G</b>	Fan Relay
<b>C</b>	24 Volt AC Transformer Common <b>[note 1, 3]</b>

#### NOTES - Conventional Systems

- [1]** Optional 24 Volt AC common connection (required for Wi-Fi).
- [2]** Remove factory installed jumper for dual transformer systems.
- [3]** In dual transformer systems, transformer common must come from cooling transformer.
- [4]** If needed for system.

*Provide disconnect and overload protection as required.*

## Heat Pump Systems

### Typical Wiring Configurations

**NOTE:** The “System Type” option will be configured in the Installer Settings section.

#### 1 HEAT / 1 COOL - No Auxiliary Heat

Set System Type to **11HP**

<b>Rh</b>	24 Volt AC Power
<b>Rc</b>	Connected to Rh with supplied Jumper Wire
<b>O/B</b>	Changeover Valve <b>[note 2]</b>
<b>Y1</b>	Compressor Relay
<b>G</b>	Fan Relay
<b>C</b>	24 Volt AC Transformer Common <b>[note 1]</b>

#### 2 HEAT / 2 COOL - No Auxiliary Heat

Set System Type to **32HP**

<b>Rh</b>	24 Volt AC Power
<b>Rc</b>	Connected to Rh with supplied Jumper Wire
<b>O/B</b>	Changeover Valve <b>[note 2]</b>
<b>Y1</b>	Compressor 1 Relay (1st stage heating/cooling)
<b>Y2</b>	Compressor 2 Relay (2nd stage heating/cooling)
<b>G</b>	Fan Relay
<b>C</b>	24 Volt AC Transformer Common <b>[note 1]</b>
<b>L</b>	Optional System Fault Monitor <b>[note 4]</b>

#### 2 HEAT / 1 COOL - Including Auxiliary Heat

Set System Type to **22HP**

<b>Rh</b>	24 Volt AC Power
<b>Rc</b>	Connected to Rh with supplied Jumper Wire
<b>O/B</b>	Changeover Valve <b>[note 2]</b>
<b>Y1</b>	Compressor Relay (1st stage heating/cooling)
<b>W2</b>	Auxiliary Heat Relay (2nd stage heating) <b>[note 3]</b>
<b>E</b>	Emergency Heat Relay <b>[note 3]</b>
<b>G</b>	Fan Relay
<b>C</b>	24 Volt AC Transformer Common <b>[note 1]</b>
<b>L</b>	Optional System Fault Monitor <b>[note 4]</b>

#### 3 HEAT / 2 COOL – Including Auxiliary Heat

Set System Type to **32HP**

<b>Rh</b>	24 Volt AC Power
<b>Rc</b>	Connected to Rh with supplied Jumper Wire
<b>O/B</b>	Changeover Valve <b>[note 2]</b>
<b>Y1</b>	Compressor 1 Relay (1st stage heating/cooling)
<b>Y2</b>	Compressor 2 Relay (2nd stage heating/cooling)
<b>AUX</b>	Auxiliary Heat Relay (3rd stage heating) <b>[note 3]</b>
<b>E</b>	Emergency Heat Relay <b>[note 3]</b>
<b>G</b>	Fan Relay
<b>C</b>	24 Volt AC Transformer Common <b>[note 1]</b>
<b>L</b>	Optional System Fault Monitor <b>[note 4]</b>

#### NOTES - Heat Pump Systems

- [1]** Optional 24 Volt AC common connection (required for Wi-Fi).
- [2]** O (cool active) or B (heat active) is selected in the Installer Settings menu.
- [3]** Install a field supplied jumper between the W2/AUX and W1/E terminals if there is no separate emergency heat relay installed.
- [4]** If the L terminal is used, the 24 Volt AC common must be connected (C terminal).

*Provide disconnect and overload protection as required.*

## Additional Wiring Options - All System Types

**NOTE:** Additional options are configured in the *Installer Settings* section.

<b>S1</b>	Indoor or Outdoor Remote Sensor <b>[note 1]</b>
<b>S2</b>	
<b>A</b>	Economizer, Fresh Air or Output Control
<b>K</b>	Share-a-Wire™ Module <b>[note 2]</b>

### NOTES - Additional Wiring Options

- [1]** Can be used to connect a Braeburn® indoor or outdoor wired remote sensor.
- [2]** Can be used to share a wire on existing installations where a common connection (C wire) is required.

## 4 Attach Thermostat to Sub-Base

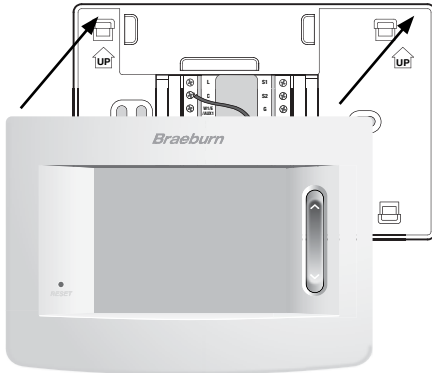

- 1) Line up the thermostat body with the sub-base.
- 2) Carefully push the thermostat body against the sub-base until it snaps in place.



- 3) Insert Quick Reference Card into slot on top of thermostat.

**NOTE:** This thermostat ships configured as a 1H/1C conventional thermostat. Confirm installer settings. See page 9.

### 3 Quick Reference

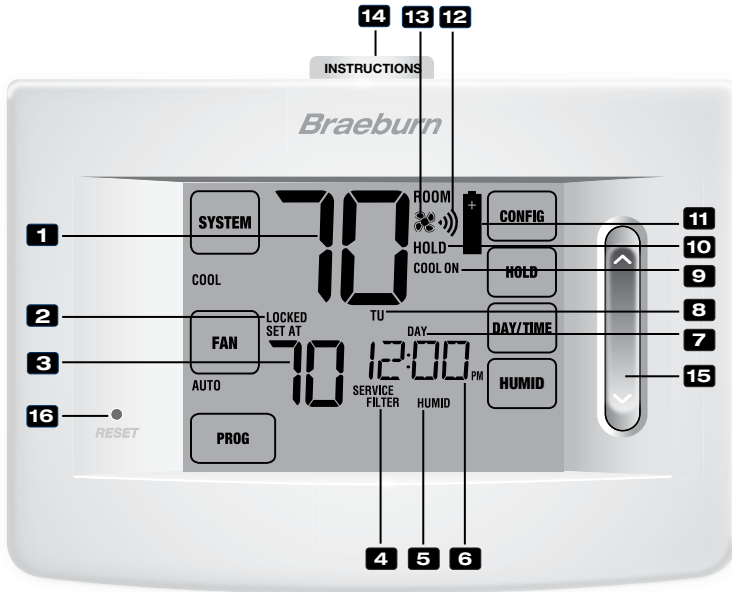

#### Thermostat Display

- 1** Room Temperature ..... Displays the current room temperature
- 2** Lock Mode Indicator ..... Indicates if the thermostat is locked
- 3** Set Temperature ..... Displays the current set point temperature
- 4** Service Indicators ..... Displays various service/maintenance information
- 5** Humidity Indicator ..... Indicates when there is a call for humidification or dehumidification
- 6** Time of Day ..... Displays the current time of day
- 7** Program Event Indicator ..... Displays the program event
- 8** Day of the Week ..... Displays the current day of the week
- 9** System Status Indicator ..... Displays information about the status of the system
- 10** Hold Mode Indicator ..... Indicates if the thermostat is in HOLD mode
- 11** Low Battery Indicator ..... Indicates when the batteries need to be replaced
- 12** Wi-Fi/Wireless Indicator ..... Indicates when connected to Wi-Fi/wireless (flashes when connection has been lost)
- 13** Fan Indicator ..... Indicates when the system fan is running

#### Thermostat

- 14** Quick Reference Instructions ..... Stored in slot located at top of thermostat
- 15** SpeedBar® ..... Increases or decreases settings (time, temperature, etc.)
- 16** Reset Button ..... Resets current time, program and user settings
- Battery Compartment ..... Located in the back of thermostat



## Thermostat TouchPads

*NOTE: Thermostat TouchPads are located on the left, right and bottom portions of the display screen. They are the “touch sensitive” segments used to adjust your thermostat. Depending on the equipment installed, all touch pads may not show.*

- SYSTEM**.....Selects AUTO (Heat/Cool), COOL, OFF HEAT or EMER (Emergency Heat)
- FAN**.....Selects AUTO, ON, CIRC (Circulation) and PROG (Program) fan modes
- PROG**..... Selects programming mode or press for 3 seconds to select SpeedSet® mode
- HOLD**..... Enters / Exits the HOLD mode (program bypass)
- DAY/TIME**... Sets the current time and day of the week
- BACK**..... Moves back in setting and programming modes
- NEXT**..... Moves forward in setting and programming modes
- RETURN**..... Returns to normal mode from program or settings modes
- CONFIG**..... Enters the User and Installer settings modes
- HUMID**..... Displays or adjusts the current humidity level

### Outdoor Temperature

If an outdoor temperature sensor was connected, you may touch the room temperature area of the screen to view the outdoor temperature.



## 4 Installer Settings

The Installer Settings must be properly configured in order for this thermostat to operate correctly. The Installer Settings are menu driven. The portion of these settings that do not apply to your setup will be skipped. These settings are indicated below with comments. More detail on each setting follows this table.

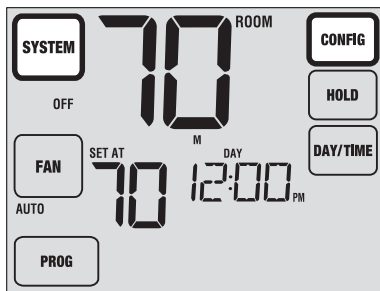

1. Touch and hold down the **SYSTEM** and **CONFIG** TouchPads for 3 seconds.
2. Release both buttons and the first installer setting will be displayed.
3. Change settings as required using the **UP** or **DOWN** portion of the SpeedBar®.
4. Touch **NEXT** or **BACK** to move to the next or previous setting, touch **RETURN** to exit.

No.	Installer Setting (Notes follow this table)	Factory Default	Setting Options	Comments (More information follows this table)
1	Residential or or Commercial Profile	RES	RES COMM	Select for Residential profile Select for Commercial profile
2	Programming Mode [note 1]	7PROG	7PROG 5-2 PROG NO PROG	Select for 7 day programming mode Select for 5-2 day programming mode Select for non-programmable mode
3	Clock Format	12 HR	12 HR 24 HR	Select for 12 hour clock Select for 24 hour clock
4	Temperature Scale	F DEG	F DEG C DEG	Select for Fahrenheit display Select for Celsius display
5	Auto Changeover	oF AUTO	oF AUTO oN AUTO	Disables Auto Changeover mode Enables Auto Changeover mode
6	System Type	11CONV	11CONV 22CONV 11HP 22HP 32HP	Select for 1H/1C Conventional system Select for 2H/2C Conventional system Select for 1H/1C Heat Pump system Select for 2H/2C Heat Pump system Select for 3H/2C Heat Pump system
7	1st Stage Differential	0.5 DIF1	0.5, 1.0 or 2.0 DIF1	Select a 1st stage temperature differential of .5°, 1° or 2° F (.25°, .5° or 2° C)
8	2nd Stage Differential [note 2]	2.0 DIF2	1.0, 2.0, 3.0, 4.0, 5.0 or 6.0 DIF2	Select a 2nd stage temperature differential of 1°, 2°, 3°, 4°, 5° or 6° F (.5°, 1°, 1.5°, 2°, 2.5° or 3° C)
9	3rd Stage Differential [note 2]	2.0 DIF3	1.0, 2.0, 3.0, 4.0, 5.0 or 6.0 DIF3	Select a 3rd stage temperature differential of 1°, 2°, 3°, 4°, 5° or 6° F (.5°, 1°, 1.5°, 2°, 2.5° or 3° C)
10	1st Stage Fan Control [note 3]	HG FAN 1	HG FAN 1 HE FAN 1	Select for 1st stage Gas heating Select for 1st stage Electric heating
11	Emergency Heat] Fan Control [note 4]	HE EMER	HE EMER HG EMER	Select for Electric Emergency Heat Select for Gas Emergency Heat
12	Reversing Valve (O/B Terminal) [note 5]	REVO	REVO REVB	Select for cool active Reversing Valve (O terminal) Select for heat active Reversing Valve (B terminal)

No.	Installer Setting (Notes follow this table)	Factory Default	Setting Options	Comments (More information follows this table)
13	Fossil Fuel Backup Heat <b>[note 4]</b>	AE AUX	AE AUX AG AUX	Select for Electric Auxiliary heat (with compressor) Select for Gas Auxiliary heat (without compressor)
14	Compressor Power Outage Protection <b>[notes 4, 6]</b>	oF CPOP	oF CPOP oM CPOP	Disables Power Outage Lockout Delay Enables Power Outage Lockout Delay
15	AC Power Interrupt Warning <b>[note 6]</b>	AC oF MONR	AC oF MONR AC oM MONR	Disables AC Power Interrupt Warning Enables AC Power Interrupt Warning
16	Compressor Short Cycle Protection	5 CSCP	5, 4, 3, 2 or 0 CSCP	Select a compressor short cycle protection delay of 5, 4, 3, 2 or 0 minutes
17	Residual Cooling Fan Delay	60 FAN	90, 60, 30 or 0 FAN	Select a Residual Cooling Fan Delay of 90, 60, 30 or 0 seconds.
18	Circulating Fan Lock	oF CIRC	oF CIRC oM CIRC	Disables Circulating Fan Lock mode Enables Circulating Fan Lock mode
19	Adaptive Recovery Mode (ARM™) <b>[note 7]</b>	oF REC	oF REC oM REC	Disables Adaptive (early) Recovery mode Enables Adaptive (early) Recovery mode
20	Indoor Remote Sensor Control* <b>[note 8]</b> (wireless sensors must be paired)	1 SENS	1 SENS E SENS  A SENS	Temperature is sensed from thermostat only. Temperature is sensed from remote sensor(s) only. (averaged if more than one) Temperature is averaged with the thermostat and the remote sensor(s).
21	Lockout Security Level (set 3-digit code in user settings)	2 LOCK	2 LOCK  1 LOCK	If locked – Complete lockout is enabled If locked – Partial lockout is enabled (SpeedBar® is still functional)
22	Auto Changeover Dead Band <b>[note 10]</b>	3 BAND	2, 3, 4 or 5 BAND	Select a Dead Band of 2°, 3°, 4° or 5° F (1°, 2° or 3° C) for Auto Changeover mode.
23	Compressor Balance Point <b>[notes 4, 10]</b>	NO BALC	NO BALC 0-50 BALC	Disables Balance Points Select a Compressor Balance Point of 0° - 50°F (-18° - 10° C)
24	Auxiliary Heat Balance Point <b>[notes 4, 10]</b>	NO BALA	NO BALA 70-40 BALA	Disables Balance Points Select a Auxiliary Heat Balance Point of 70°- 40° F (21° - 4° C)
25	Economizer Fresh Air or Output Control <b>[note 11]</b>	OR NONE	OR NONE OR ECON OR TOD	Disables Fresh Air Intake option Enables Fresh Air Intake (Economizer Mode) Enables Fresh Air Intake (Time of Day Mode)
26	Heat Set Point Upper Limit	90 LIM	90-60 LIM	Select a Heat Set Point Upper Limit of 90°-60° F (32°-10° C)
27	Cool Set Point Lower Limit	45 LIM	45-80 LIM	Select a Cool Set Point Lower Limit of 45°-80° F (7°-27° C)
28	Humidification <b>[note 12]</b>	OFF	OFF DEP IND	Disables Humidification Enables Dependant Humidification Enables Independent Humidification
29	Auto Humidity Set Point Limit <b>[notes 10, 12]</b>	AUTO	AUTO  MAN	Enables automatic humidity control based on outdoor temperature. Enables manual humidity control from thermostat.
30	Dehumidification <b>[note 12]</b>	OFF	OFF NI NA	Disables Dehumidification Normally inactive (open) relay Normally active (closed) relay
31	Installer Clear	CLR0	CLR0 CLR1 CLR2	Clear Off - No changes made to settings Clears wireless remote sensor settings Clears all thermostat settings (factory defaults)

Options (shaded) 28 - 30 only appear if optional wireless remote humidity sensor is installed.

\*When an outdoor sensor is connected, the thermostat automatically recognizes it. Press room temperature digits to display outdoor temperature.

**NOTE:** Additional options such as Service Monitors, Setting the lock code, audible tone, etc. are located in the User Settings – See User manual for information on setting these options.

## NOTES - Installer Settings

- 1 Only available if Residential profile was selected in option 1.
- 2 Only available if a 2 or 3 stage system type was selected in option 6.
- 3 Only available if a Conventional system was selected in option 6.
- 4 Only available if a 2 or 3 stage Heat Pump system was selected in option 6.
- 5 Only available if a Heat Pump system was selected in option 6.
- 6 Only available if the 24 Volt AC common wire is connected to the C terminal.
- 7 Only available if a programmable profile was selected in option 2.
- 8 Only available if a Braeburn® indoor remote sensor is connected (wired or wireless).
- 9 Only available if auto changeover was enabled in option 5.
- 10 Only available if a Braeburn outdoor sensor was connected.
- 11 Only available if Commercial profile was selected in option 1.
- 12 Only available if a Braeburn wireless humidity sensor (Model 7330) is connected.

### Detailed Explanation of Installer Settings (also see NOTES above):

- 1 **Profile** – Selects a residential (RES) or commercial (COMM) profile. If residential is selected, 4 programming events per day are available. If commercial is selected, 2 event, 7 day programming is available.
- 2 **Programming Mode [note 1]** – Selects the programming mode, either full 7 day or 5-2 day (weekday/ weekend) programming or non-programmable.
- 3 **Clock Type** – Selects either a 12 hour or 24 hour clock.
- 4 **Temperature Scale** – Selects a temperature scale of either °F or °C.
- 5 **Auto Changeover** – Selects auto changeover on or off. When auto changeover mode is enabled and selected, the system automatically switches between heating and cooling modes. There is a 5 minute delay when switching from heating to cooling or cooling to heating in auto changeover mode.  
**NOTE:** Also see “Auto Changeover Dead Band” in option 22.
- 6 **System Type** – Selects the system type for your installation. **NOTE:** Changes made to this option will reset options 7 through 14 back to their default values dependant on the system type.
- 7 **1st Stage Differential** – Selects a 1st stage temperature differential.
- 8 **2nd Stage Differential [note 2]** – Selects a 2nd stage temperature differential.
- 9 **3rd Stage Differential [note 2]** – Selects a 3rd stage temperature differential.
- 10 **1st Stage Fan Control [note 3]** – Selects a 1st stage fan control of either gas or electric heat.
- 11 **Emergency Heat Fan Control [note 4]** – Selects emergency heat fan control of either gas or electric heat.
- 12 **Reversing Valve [note 5]** – Selects the output state of the O/B terminal. Select O for this terminal to be active in the cool mode or select B for this terminal to be active in the heat mode.
- 13 **Auxiliary Fossil Fuel Heat Pump Control [note 4]** – When set to electric (AE AUX), both the compressor (1st stage) and auxiliary stage(s) will run when a call for auxiliary heat is made. When set to gas (AG AUX), the compressor stage(s) will be locked out one minute after a call for auxiliary heat. **NOTE:** This option can be overridden if setting an auxiliary heat balance point in Option 24.
- 14 **Compressor Power Outage Protection [notes 4, 6]** – Selects power outage protection on or off. When enabled, this thermostat will provide cold weather compressor protection by locking out the compressor stage(s) of heating for a period of time after a power outage greater than 60 minutes.

- 15 AC Power Interrupt Warning [note 6]** – When enabled, the thermostat will display an outage warning when AC power to the thermostat is lost.
- 16 Short Cycle Protection** – Selects the number of minutes the cooling compressor will be locked out after turning off. This short cycle protection is also active in the heat mode if a heat pump system was selected in Option 6.
- 17 Residual Cooling Fan Delay** – Selects a delay for the system fan after the cooling compressor has turned off. This delay will help remove the remaining cool air out of the ductwork providing additional efficiency.
- 18 Circulating Fan Lock** – When enabled, the only user fan options available are ON and CIRC (Circulation). The AUTO option is not available with this option enabled.
- 19 Adaptive Recovery Mode (early recovery) [note 7]** – Enables or disables the ARM™ (adaptive recovery mode) feature. During ARM, room temperature is recovered by turning on the heating or cooling before the end of the set back period. The set point temperature is changed to that of the upcoming program temperature.
- 20 Indoor Remote Sensor Control [note 8]** – If a Braeburn® indoor remote sensor is connected (wired) or paired (wireless) during installation, the thermostat will automatically detect the sensor. When an indoor sensor is detected, you may select between thermostat only (I SENS), remote sensor only (E SENS) or combining the thermostat and the remote sensor(s) (A SENS).  
**NOTE:** This option does not apply to the Braeburn outdoor sensor. When an outdoor sensor is connected (wired) or paired (wireless), the thermostat automatically recognizes it and no further configuration is necessary.
- 21 Lockout Security Level** – Selects the level of keypad lockout when the thermostat is locked. Level 2 locks the entire thermostat (including the front reset button). Level 1 locks everything except the SpeedBar® allowing for up and down temperature adjustment. **NOTE:** The lock code is set in the User Settings mode (see User Manual).
- 22 Auto Changeover Dead Band [note 9]** – When auto changeover mode is enabled in option 5 and selected, the system automatically switches between heating and cooling when the room temperature meets the normal criteria for either a heating or cooling call. There is a forced separation (dead band) between the heating and cooling set points so that the systems do not work against each other. This option selects the amount of this dead band in degrees with the default being 3° F.
- 23 Compressor Balance Point [notes 4, 10]** – Locks out the use of the compressor heat stage when the outside air temperature is less than the selected setting of 0 °F to 50 °F (-9° C to 10° C)
- 24 Auxiliary Heat Balance Point [notes 4, 10]** – Locks out the use of the auxiliary heat stage when the outside air temperature exceeds the selected setting of 70° F to 40° F (21° C to 4° C). **NOTE:** This balance point overrides the fossil fuel compressor lockout in option 13. If this option is set to gas and the outdoor temperature is over the auxiliary balance point, the compressor will remain on during a call for auxiliary heat.

**25 Economizer, Fresh Air or Output Control [note 11]** – Selects control options. Select between disabled (NONE), economizer mode (ECON) and time of day (TOD) mode.

Time Step / Override	Cooling Call	External Air or Output Control (A)		
		Economizer Mode	Time of Day Mode	Disabled
Occupied	YES or NO	ON	ON	OFF
Unoccupied	YES	ON	OFF	OFF
	NO	OFF	OFF	OFF
Override	YES or NO	ON	ON	OFF

Time Step / Override	Heating Call	External Air Output (A)		
		Economizer Mode	Time of Day Mode	Disabled
Occupied	YES or NO	ON	ON	OFF
Unoccupied	YES	OFF	OFF	OFF
	NO	OFF	OFF	OFF
Override	YES or NO	ON	ON	OFF

**26 Heat Set Point Upper Limit** – Selects the heating set point upper adjustment limit.

**27 Cool Set Point Lower Limit** – Selects the cooling set point lower adjustment limit.

**28 Humidification Mode [note 12]** – For use with an external humidifier. Selects between disabling humidification (OFF), dependent control (DEP) or independent control (IND). The DEP setting controls humidification only during a call for heating. The IND setting allows humidification output in the heat mode, but does not require a call for heating. **NOTE:** *It is recommended that the IND setting only be used with systems designed for low air temperature humidification such as steam humidification. Always ensure the heat exchanger or other system parts are not exposed to excess water from condensation or other sources. When there is any doubt, use the OFF or DEP setting.*

**29 Auto Humidity Set Point Limit [notes 10, 12]** – Select between turning the automatic humidity set point limit to auto (AUTO) or manual (MAN). When AUTO is selected, humidity control is provided automatically based on the outdoor temperature. Selecting MAN allows you to manually control the level of humidity.

**30 Dehumidification [note 12]** – For use with an external dehumidifier. Select between dehumidification disabled (OFF), a normally inactive (NI) or normally active (NA) relay, depending on the requirements of your external dehumidification equipment.

**31 Installer Clear** – Clears settings based on your selection. CLRO makes no changes, CLR1 clears all wireless remote sensor settings and CLR2 clears **ALL** thermostat settings to factory default.

**WARNING:** If you press NEXT or RETURN after selecting CLR1 or CLR2 the clear will take place and the appropriate settings will be returned to factory defaults. If you do not wish to make any changes, use the SpeedBar® to select CLRO.

## 5 Wireless Remote Sensors

**NOTE:** See the wireless remote sensor manual for complete installation and use instructions.

### Compatible Wireless Remote Sensors



Wireless Remote Indoor Sensor(s) – 4 sensors maximum

Wireless Remote Outdoor Sensor – 1 sensor maximum

Wireless Remote Humidity Sensor – 1 sensor maximum

**NOTE:** No more than 4 wireless remote sensors can be connected.

### Pairing Wireless Remote Sensors

- 1 Press and hold the **CONFIG** and **DAY/TIME** buttons for 3 seconds.
- 2 Press **NEXT** until the word **SENS** appears in the display and the  symbol flashes.
- 3 After the remote sensor is powered, press and hold the **CONNECT** button at the sensor for 3 seconds.
- 4 The remote sensor will enter pairing mode for 60 seconds. During this time the blue LED on the wireless remote sensor will flash once every 2 seconds.
- 5 The thermostat display will change and indicate which remote sensor has been paired (see Table 1). The  symbol will stop flashing and the blue LED on the remote sensor will turn on for 60 seconds.
- 6 To pair another wireless remote sensor, press **NEXT** and repeat steps 3 - 5.
- 7 Press **RETURN** at any time to exit.

**NOTE:** Sensors that have already been paired will appear in the thermostat display first, with a solid  symbol.

<b>IDS1, IDS2, IDS3 or IDS4</b>	Remote Indoor Sensor 1-4
<b>HMS</b>	Remote Humidity Sensor
<b>ODS</b>	Remote Outdoor Sensor

Table 1

### Using Wired Remote Sensors

One wired indoor or wired outdoor remote sensor can also be connected to the thermostats S1 and S2 terminals using 2-wire thermostat cable.

You cannot mix wired and wireless remote sensors of the same type (i.e. mixing an indoor wireless remote sensor and an indoor wired remote sensor).

### Replacing a Thermostat

If you are replacing a thermostat that is paired with an existing wireless sensor, you will need to clear the remote sensor and pair it again with the newly installed thermostat.

- 1 Install the new thermostat.
- 2 On the wireless remote sensor you want to clear, press and hold the **CONNECT** button for 10 seconds until the red LED turns on solid.
- 3 Release the **CONNECT** button and the blue and red LED will each flash once to indicate the sensor was successfully cleared.
- 4 Pair the remote sensor again.

### Replacing a Sensor

If you are replacing a wireless remote sensor that is paired with an existing thermostat, you will need to clear the thermostat's remote sensor settings before pairing the new wireless remote sensor.

- 1 Install the new wireless remote sensor.
- 2 Thermostat remote sensor settings are cleared by adjusting Installer Setting 31 to CLR1 (see pages 9-10). This setting clears all the remote sensors paired with the thermostat.

**NOTE:** Be careful not to select CLR2 unless you want to clear all the thermostat settings.

- 3 Once the remote sensor settings are cleared you will need to pair your new wireless remote sensor. You will also need to pair any other existing wireless remote sensors that were previously connected.

## Wireless Remote Sensor Communication Loss

If communication between the remote sensor and thermostat is lost, the red LED on the remote sensor will begin to flash once every 10 seconds. The sensor will attempt to reconnect to the thermostat several times automatically.

**NOTE:** To attempt to reconnect manually, press and hold the **CONNECT** button for 3 seconds.

The thermostat display will also indicate which wireless remote sensor has lost communication by flashing **COMM LOSS** along with the remote sensor that has lost communication (see Table 2).

## Wireless Remote Sensor Low Battery

If the batteries in a wireless remote sensor are low, the red LED will flash 3 times every 30 seconds. The thermostat display will also indicate which wireless remote sensor has a low battery by flashing **LOW BATT** along with the remote sensor that has the low battery condition (see Table 2). Replace the remote sensor batteries immediately.

<b>IDS1, IDS2, IDS3 or IDS4</b>	Remote Indoor Sensor 1-4
<b>HMS</b>	Remote Humidity Sensor
<b>ODS</b>	Remote Outdoor Sensor

Table 2

**NOTE:** If Audible Tone is enabled in User Options (see User Manual), the thermostat will also sound a beep every 60 seconds when communication has been lost. You can press **RETURN** to cancel the beeping sound.

## 6 System Testing



### **Warning** Read Before Testing

- Do not short (or jumper) across terminals on the gas valve or at the heating or cooling system control board to test the thermostat installation. This could damage the thermostat and void the warranty.
- Do not select the **COOL** mode of operation if the outside temperature is below 50° F (10° C). This could possibly damage the controlled cooling system and may cause personal injury.
- This thermostat includes an automatic compressor protection feature to avoid potential damage to the compressor from short cycling. When testing the system, make sure to take this delay into account.

**NOTE:** The compressor delay can be bypassed by pressing the reset button on the front of the thermostat. All user settings will be returned to factory default, however all Installer settings will remain as originally programmed in section 4.

- 1 Touch the **SYSTEM** TouchPad until the thermostat is in **HEAT** mode.
- 2 Using the SpeedBar® raise the set temperature a minimum of 3 degrees above the current room temperature. The system should start within a few seconds. With a gas heating system, the fan may not start right away.
- 3 Touch **SYSTEM** until the thermostat is in the **OFF** mode. Allow the heating system to fully shut down.
- 4 Touch **SYSTEM** until the thermostat is in the **COOL** mode.
- 5 Using the SpeedBar lower the set temperature a minimum of 3 degrees below the current room temperature. The system should start within a few seconds (unless compressor short cycle protection is active – See note above).
- 6 Touch **SYSTEM** until the thermostat is in the **OFF** mode. Allow the cooling system to fully shut down.
- 7 Touch **FAN** until the thermostat is in **FAN ON** mode. The system fan should start within a few seconds.
- 8 Touch **FAN** until the thermostat is in **FAN AUTO** mode. Allow the system fan to turn off.
- 9 If the thermostat is controlling auxiliary equipment such as an economizer etc., adjust the thermostat settings to test these devices.

# Braeburn®

This equipment has been tested and found to comply with the limits for a Class B digital device, pursuant to Part 15 of the FCC Rules. These limits are designed to provide reasonable protection against harmful interference in a residential installation. This equipment generates uses and can radiate radio frequency energy and, if not installed and used in accordance with the instructions, may cause harmful interference to radio communications. However, there is no guarantee that interference will not occur in a particular installation. If this equipment does cause harmful interference to radio or television reception, which can be determined by turning the equipment off and on, the user is encouraged to try to correct the interference by one or more of the following measures:

- Reorient or relocate the receiving antenna.
- Increase the separation between the equipment and receiver.
- Connect the equipment into an outlet on a circuit different from that to which the receiver is connected.
- Consult the dealer or an experienced radio/TV technician for help.

Changes or modifications not expressly approved by the party responsible for compliance could void the user's authority to operate the equipment. This device complies with part 15 of the FCC Rules. Operation is subject to the following two conditions: (1) This device may not cause harmful interference, and (2) this device must accept any interference received, including interference that may cause undesired operation.

This device complies with Industry Canada's licence-exempt RSSs. Operation is subject to the following two conditions:

- (1) This device may not cause interference; and
- (2) This device must accept any interference, including interference that may cause undesired operation of the device.

Cet appareil est conforme aux CNR exempts de licence d'Industrie Canada. Son fonctionnement est soumis aux deux conditions suivantes :

- (1) Ce dispositif ne peut causer des interférences ; et
- (2) Ce dispositif doit accepter toute interférence, y compris les interférences qui peuvent causer un mauvais fonctionnement de l'appareil.

#### **MPEG LA License Agreement**

THIS PRODUCT IS LICENSED UNDER THE WIRELESS NETWORK PATENT PORTFOLIO LICENSE FOR USE BY A CONSUMER OR OTHER USES FOR WHICH THERE IS NO REMUNERATION. ANY OTHER USE OF THIS PRODUCT IN ANY MANNER IS NOT LICENSED AND IS EXPRESSLY PROHIBITED WITHOUT A LICENSE UNDER APPLICABLE PATENTS IN THE WIRELESS NETWORK PATENT PORTFOLIO, WHICH LICENSE IS AVAILABLE FROM MPEG LA, LLC, 4600 S. ULSTER ST., SUITE 400, DENVER, COLORADO 80237 U.S.A. SEE [HTTP://WWW.MPEGLA.COM](http://www.mpegla.com).

Please Note: This thermostat may have been updated over the internet since this manual was printed. Always refer to the support web site for the latest information.

## Limited Warranty

When installed by a professional contractor, this product is backed by a 5 year limited warranty. Limitations apply. For limitations, terms and conditions, you may obtain a full copy of this warranty:

- Visit us online: [www.braeburnonline.com/warranty](http://www.braeburnonline.com/warranty)
- Phone us: 866.268.5599
- Write us: Braeburn Systems LLC  
2215 Cornell Avenue  
Montgomery, IL 60538



***Store this manual for future reference.***

For additional information visit: [www.braeburnonline.com](http://www.braeburnonline.com)

For online access visit: [www.bluelinksmartconnect.com](http://www.bluelinksmartconnect.com)

# Braeburn®

Braeburn Systems LLC  
2215 Cornell Avenue • Montgomery, IL 60538  
Technical Assistance: [www.braeburnonline.com](http://www.braeburnonline.com)  
844-BLU-LINK (844-258-5465) (U.S.)  
630-844-1968 (Outside the U.S.)